

1085-CL

Teacher Storage

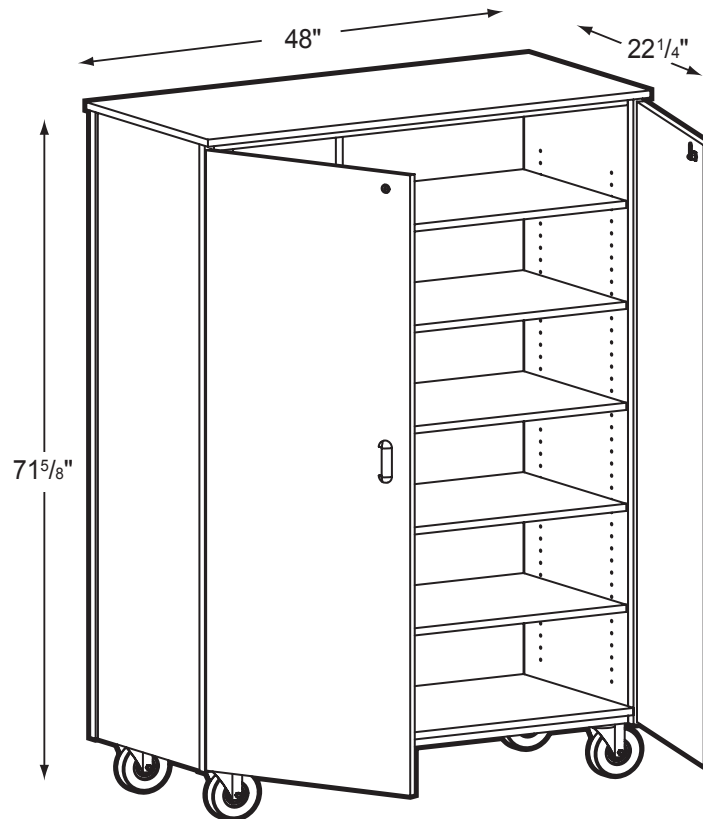

Product Specs

- Fully welded unitized frame
- 16 ga. tubing
- 10 ga. angle iron
- 3/16" caster mounting plates
- 5" casters (2 locking)
- 5mm steel shelf supports
- 5 knuckle hinges w/hospital tips
- Triple bar magnetic catch
- Hooded abs plastic four fingered pull
- Five disk cam lock
- 14" steel closet rod
- 12" x 12" mirror
- 3/4" thermal fused laminate
- 3mm PVC edge banding on all semi and exposed edges
- Five adjustable shelves 2/3 width
- 14" hat shelf

0208