

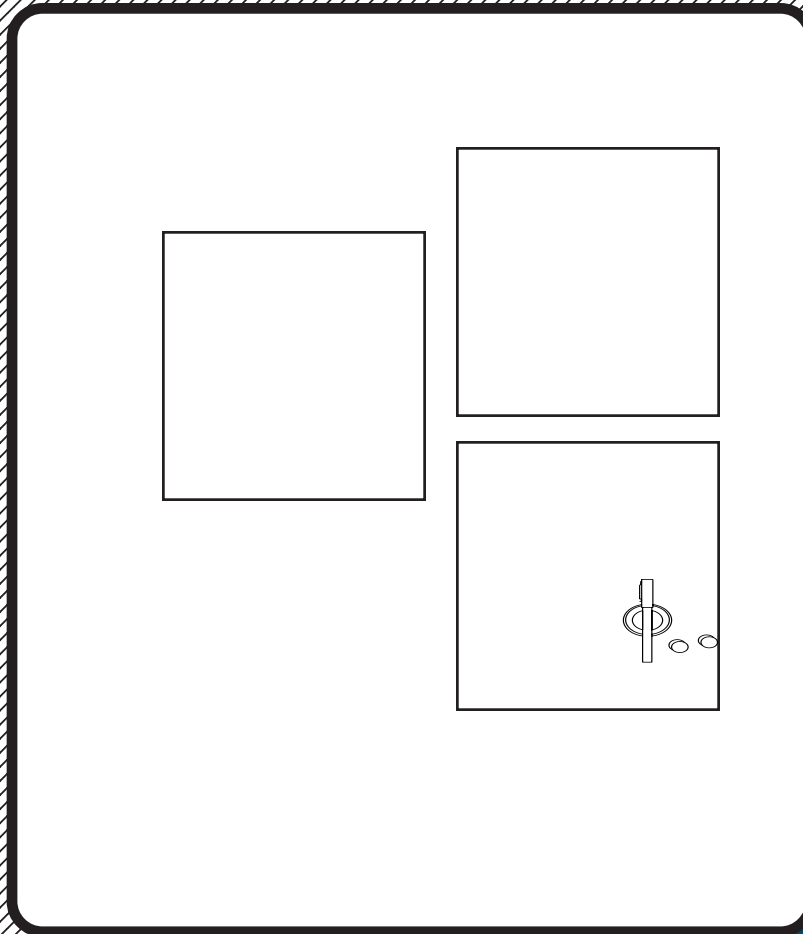



Mosaic Glass Boards

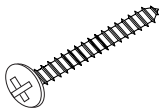
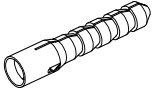
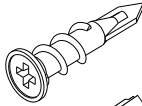
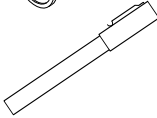

Assembly Instructions

Part	Drawing	Description	Qty
P-1		Glass Board	1 EA

Hardware List			
Part	Drawing	Description	Qty
A		Phillips Screw	4 EA
B		Plastic Anchor	4 EA
C		Dry Wall Anchor	4 EA
D		Marker Pen	1 EA
E		Eraser/Pen Holder	1 EA
F		Magnet	2 EA

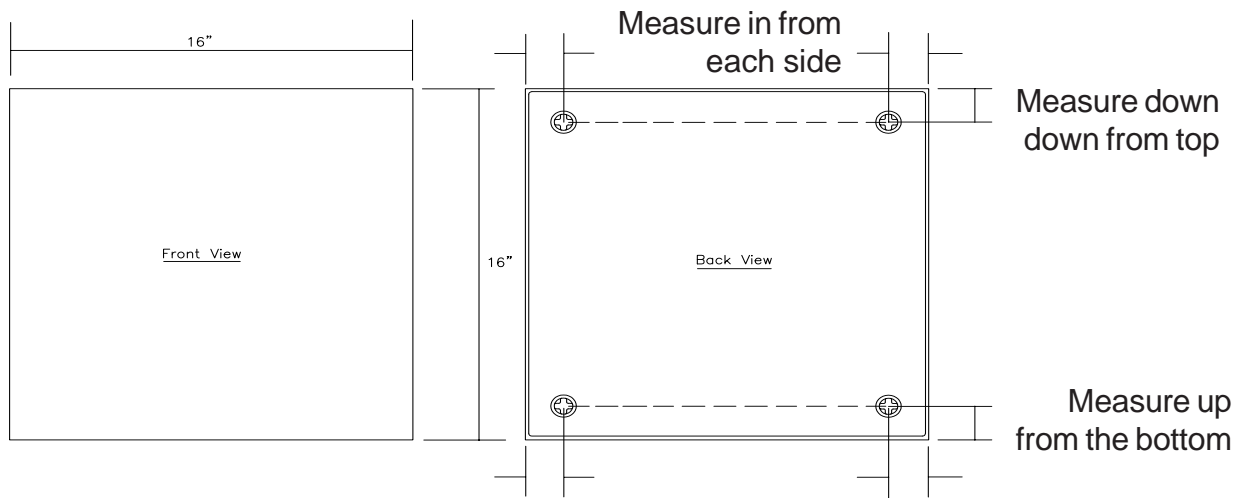
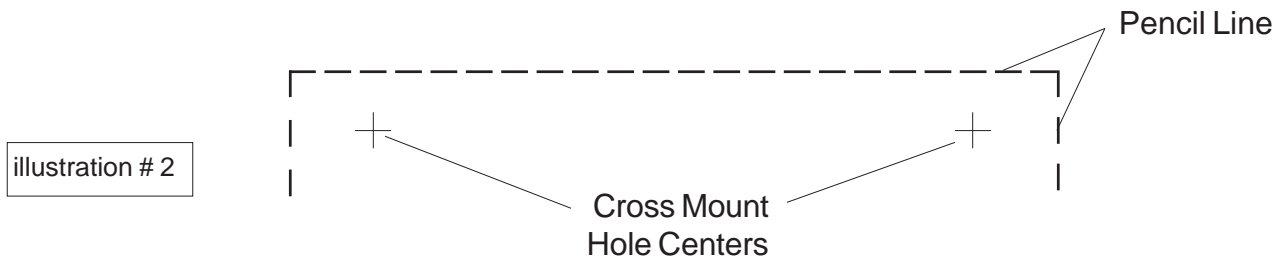

illustration # 1

1. Determine the wall location of your new Mosaic Glass Board. With a pencil, draw a light line around the outside edges of your glass board. Measure down from the top edge of the glass board to the center point of the top cross mounting hole on the back of your board. Using this dimension, draw a line below and parallel with the top edge pencil line. Measure in from each side to the center point of the cross mounting holes as shown in illustration #2.



2. Repeat Step #1 to locate and mark the bottom set of holes.
3. Determine the correct mounting hardware to use for the type wall you have. (See Detail 3a)

4. When installing Screw (A), leave a 3/16" gap between the bottom of the screw's head and the wall. Hook the Screw's head into the top Cross Mounting holes on the back of the glass board.

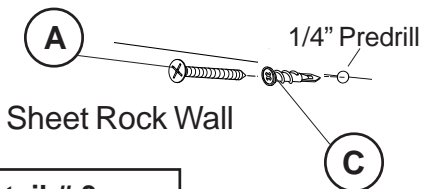
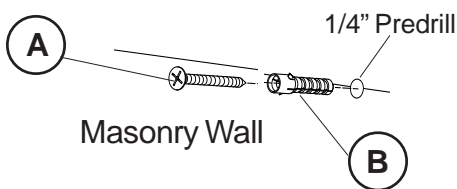
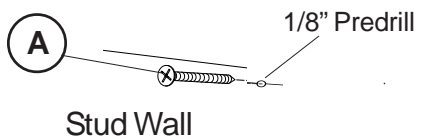

Detail # 3a

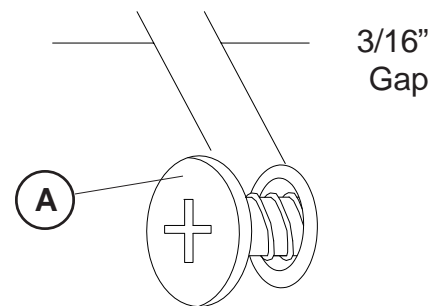

illustration # 3